

LAMBORGHINI AVENTADOR
RACER



Designed by Taras Lesko
visualspicer.com

Recommended Tools

- Craft glue
- X-Acto knife
- Scissors
- Markers

Miscellaneous

- Glue only one part at a time.
- Glue only two or three tabs at a time.
- Experiment, enjoy and have fun!

Templates

- Cut line



- Mountain fold line 



- Valley fold line 



More Info

View more details about this project at bit.ly/AventadorPapercraft or scan the QR code to view the page on your mobile device.



1

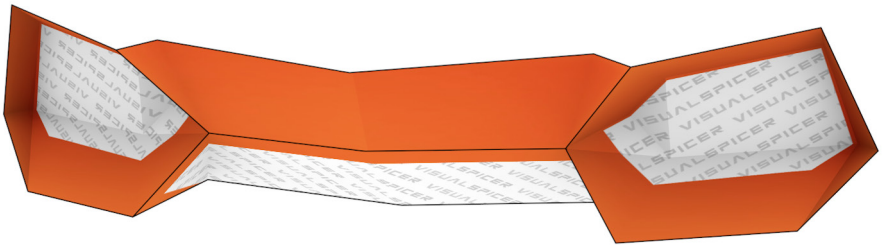
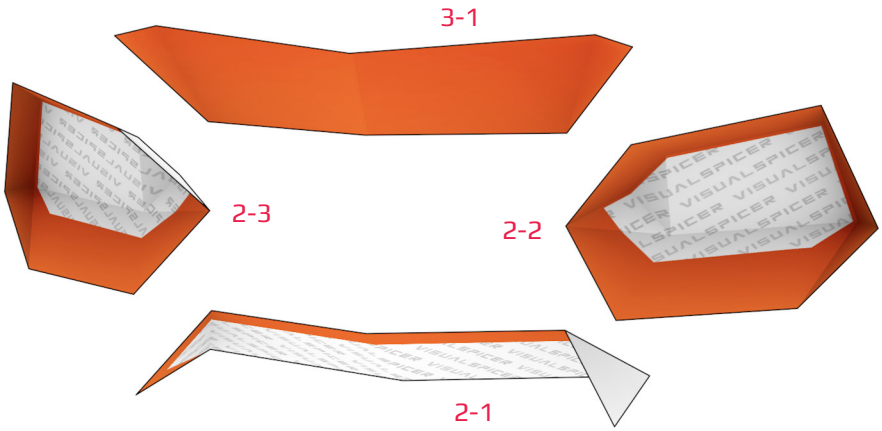

Find parts for each step by referencing Templates page number then part number. For example, **1-2** is Templates page 1, part 2.

2

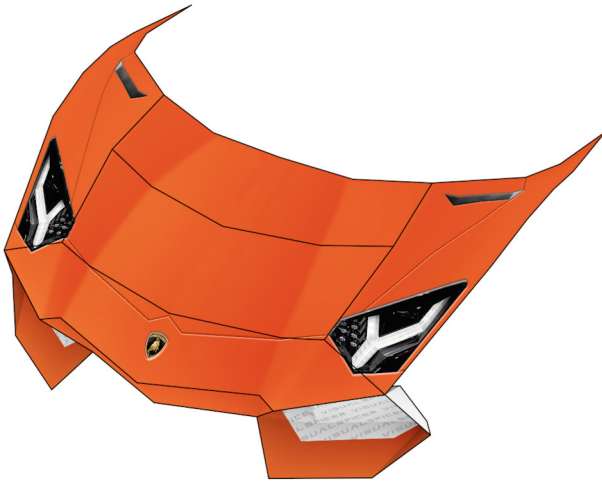
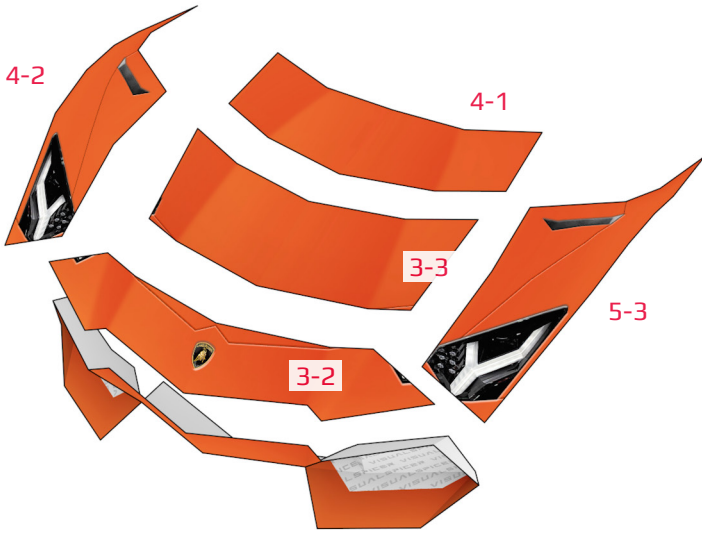

3

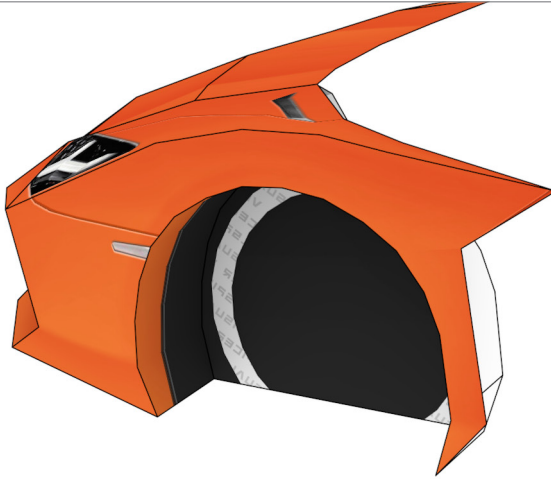
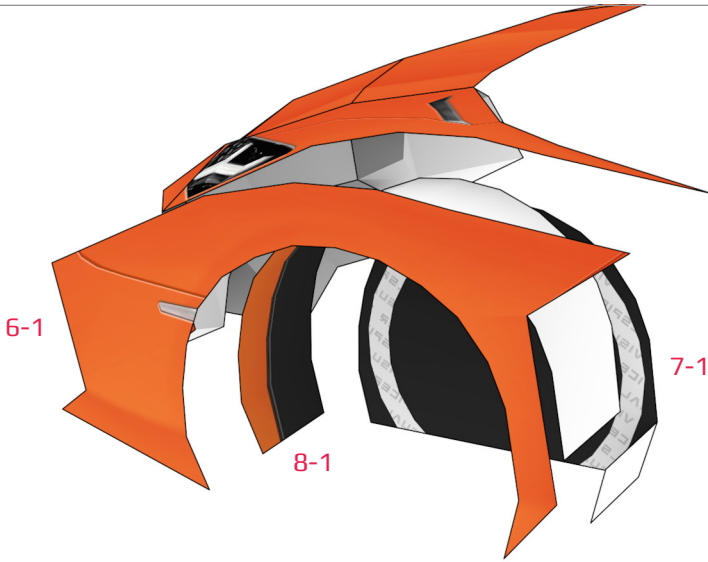

4

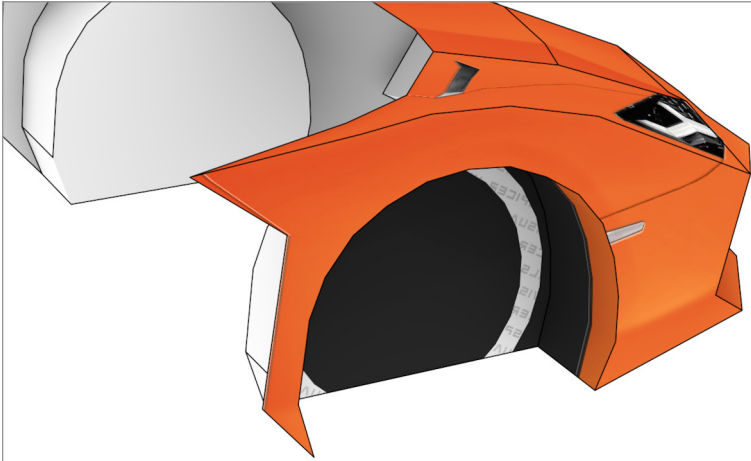
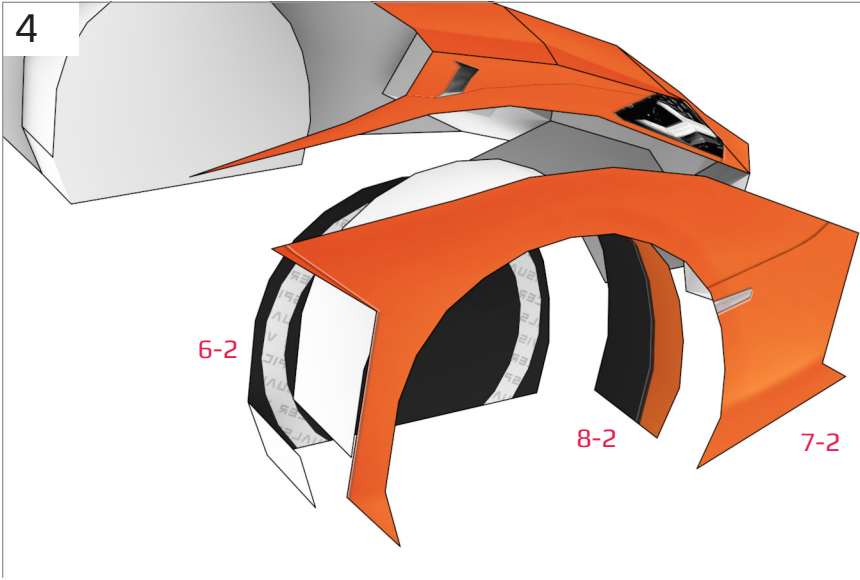

5

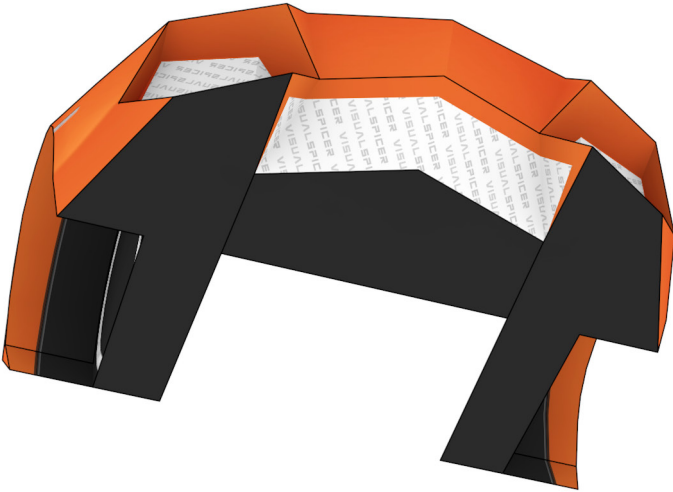
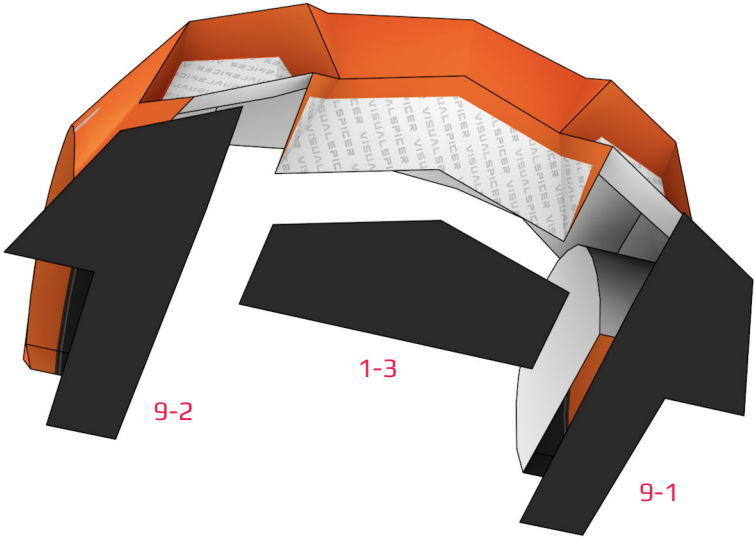

6

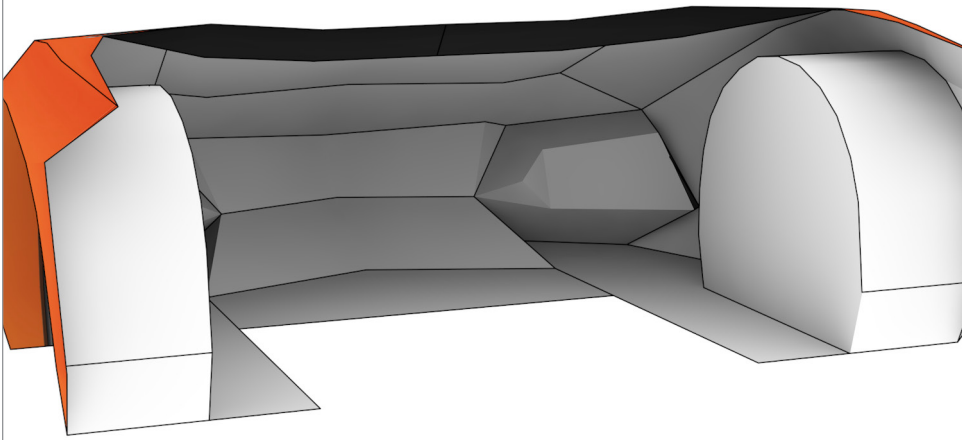
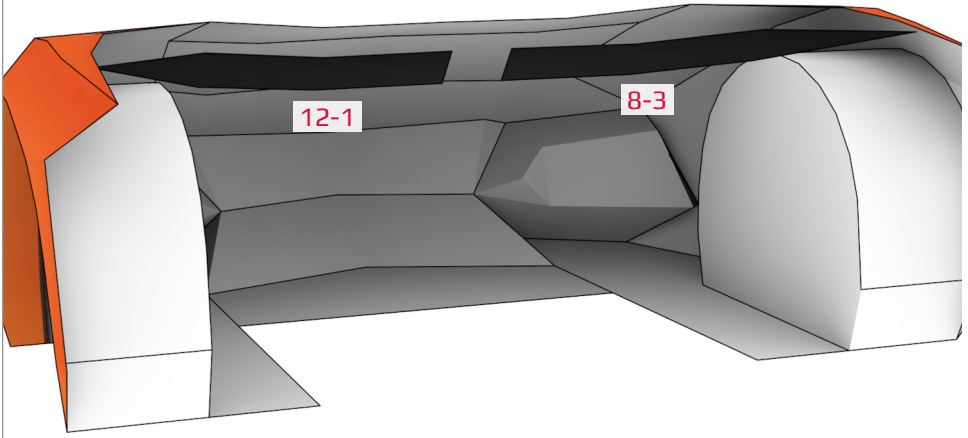

7

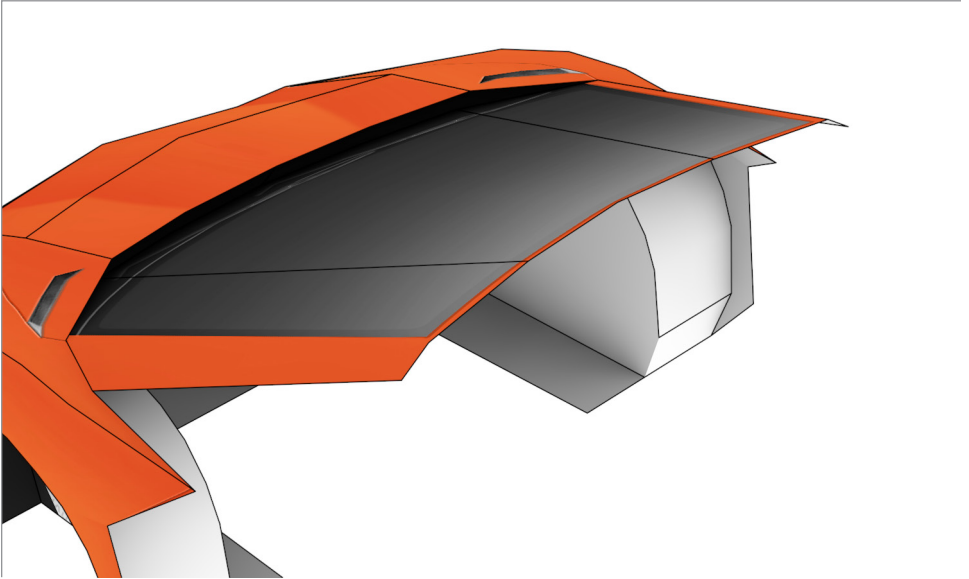
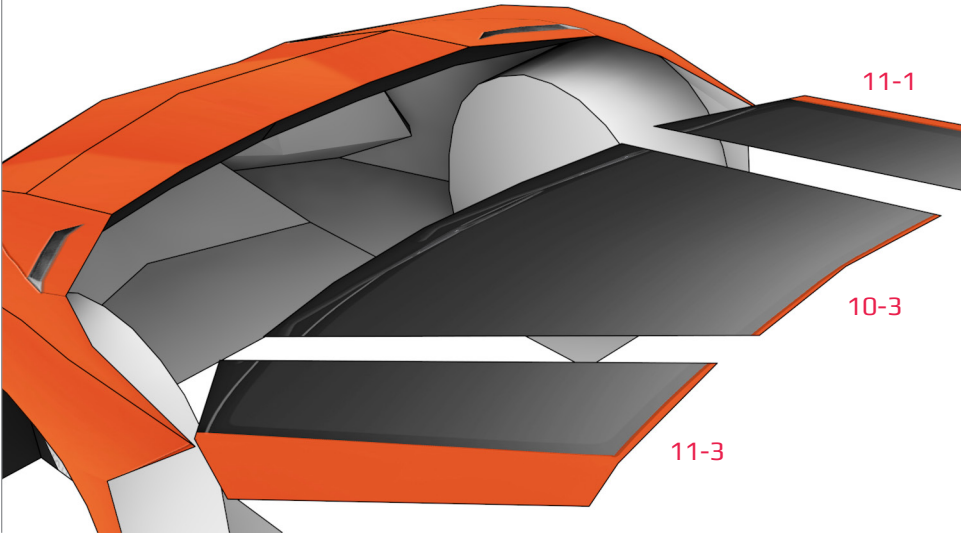

8

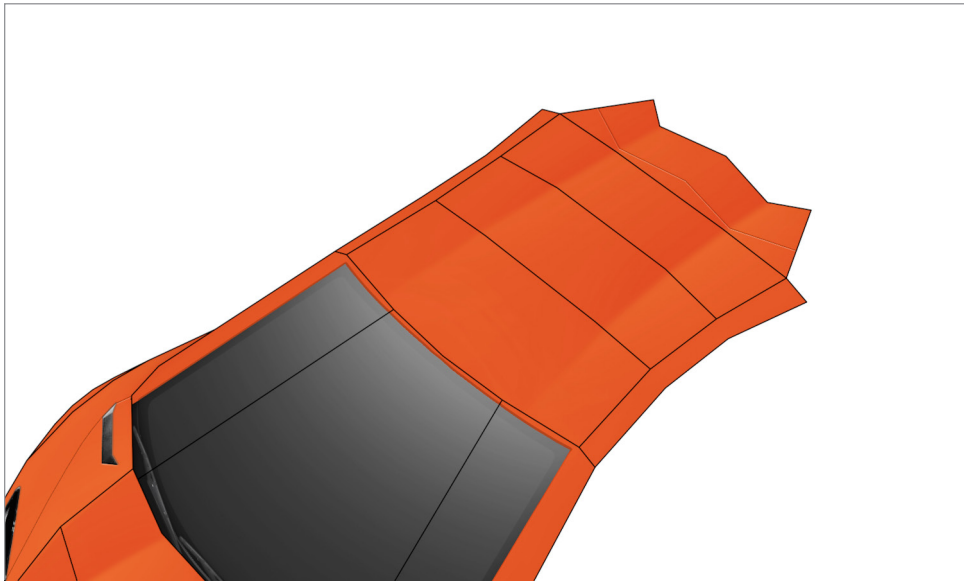
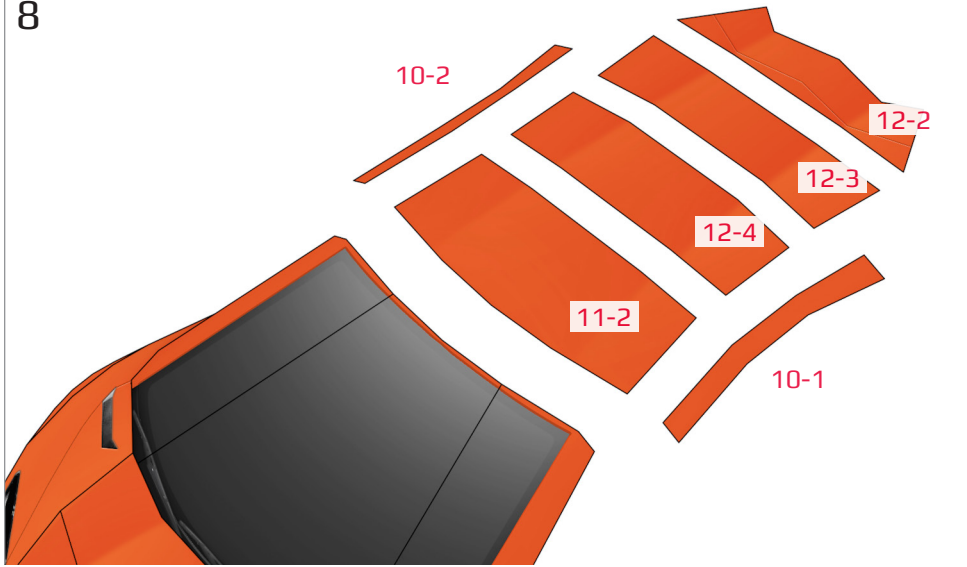

9

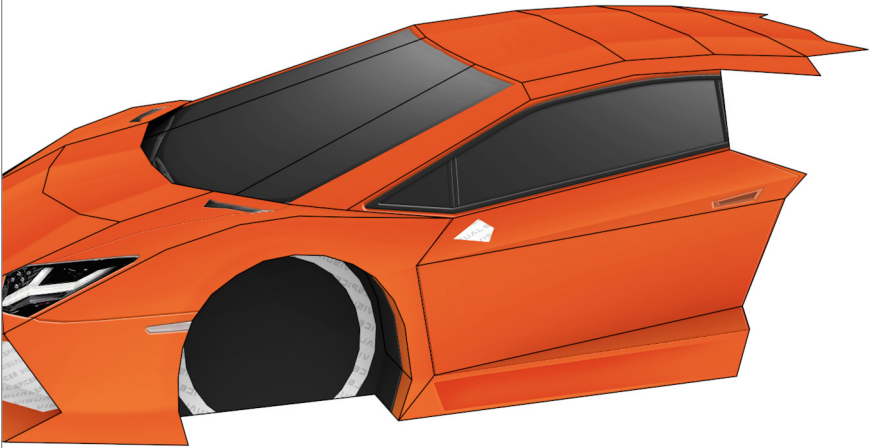
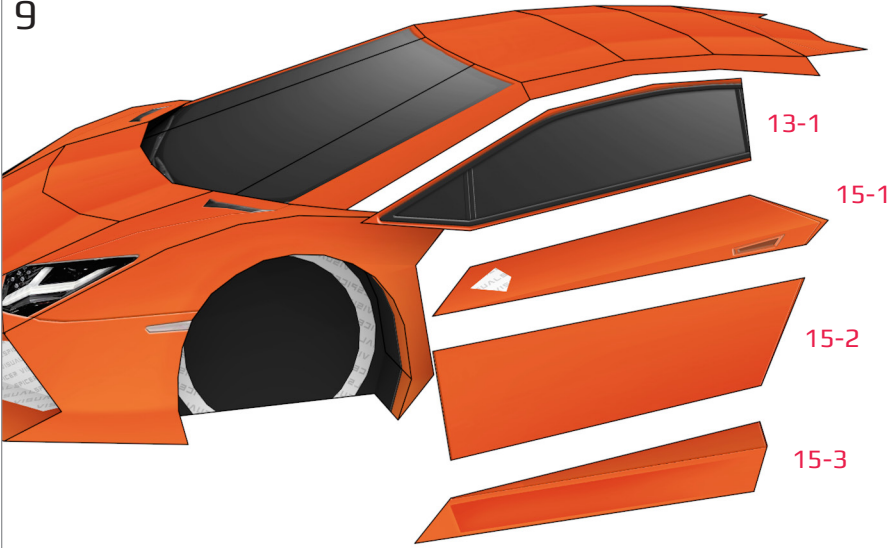

10

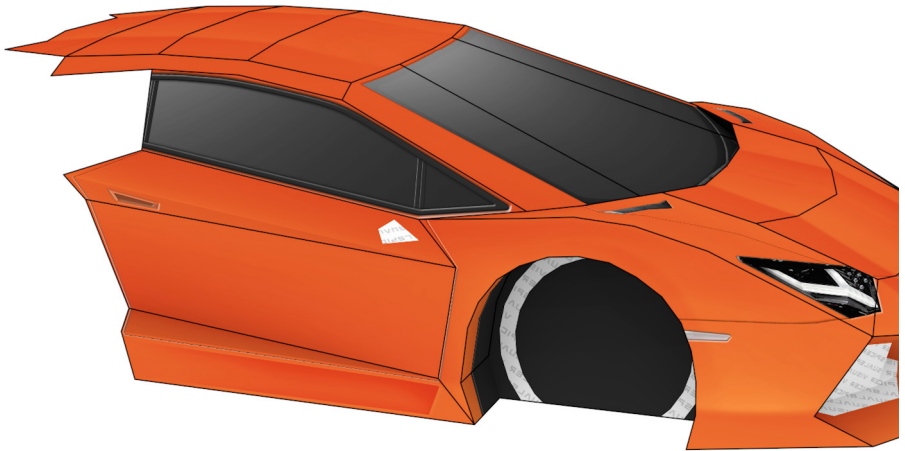
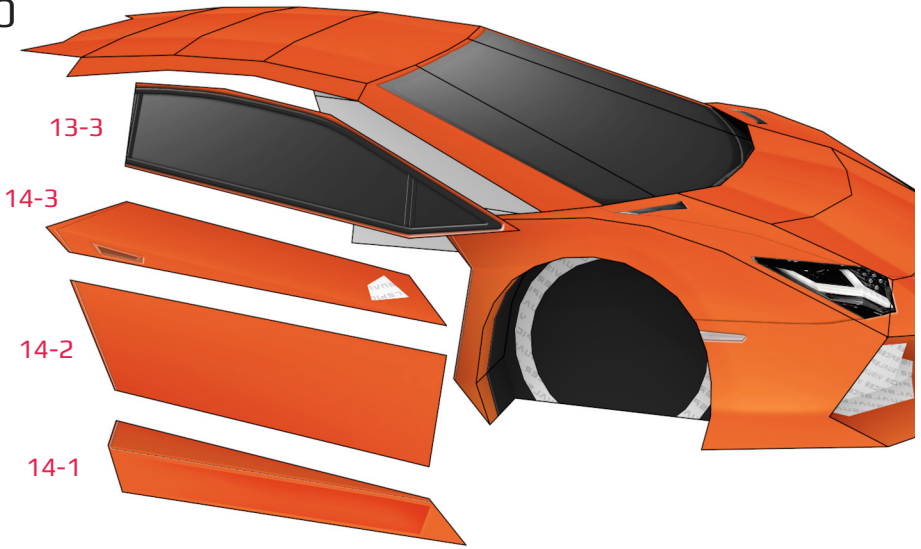

11

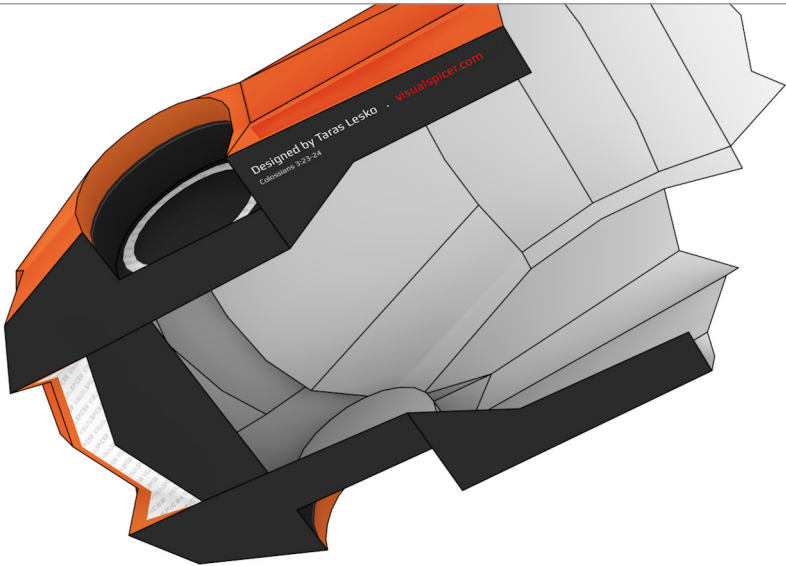
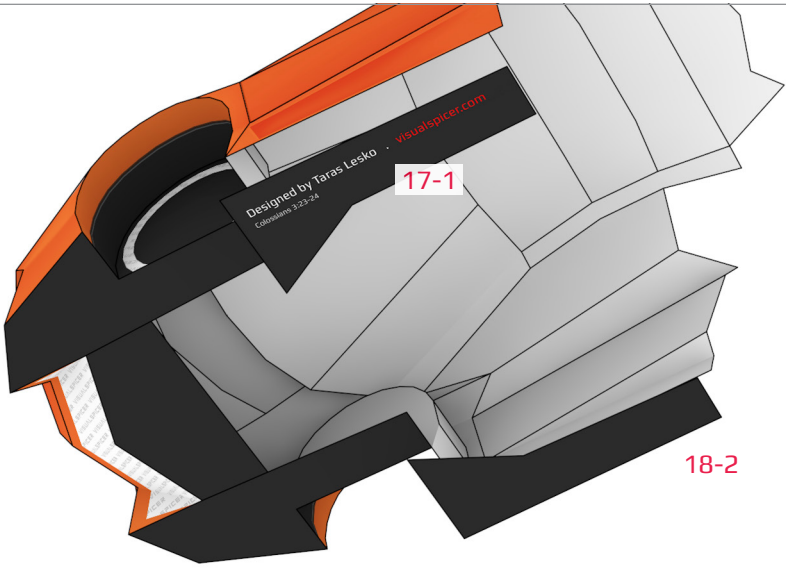

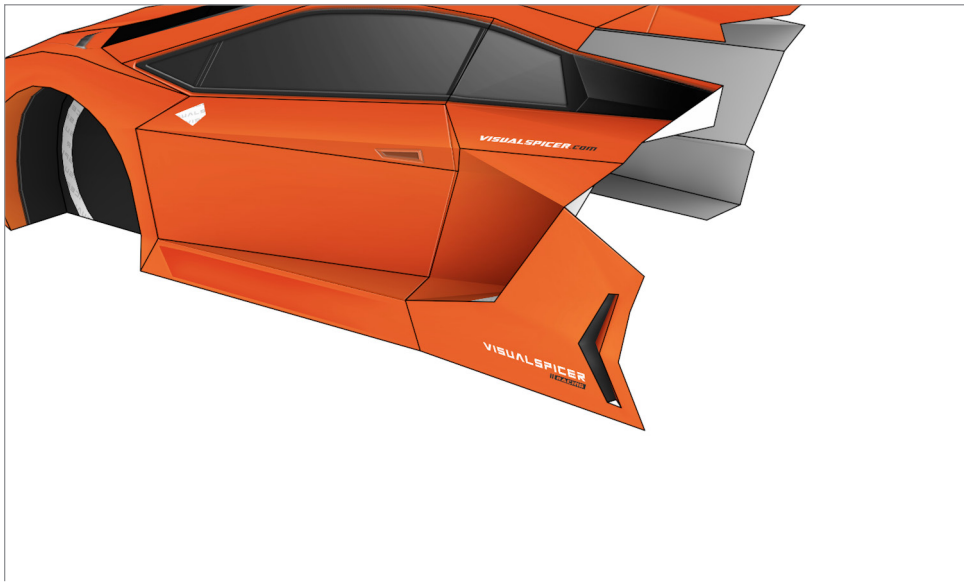
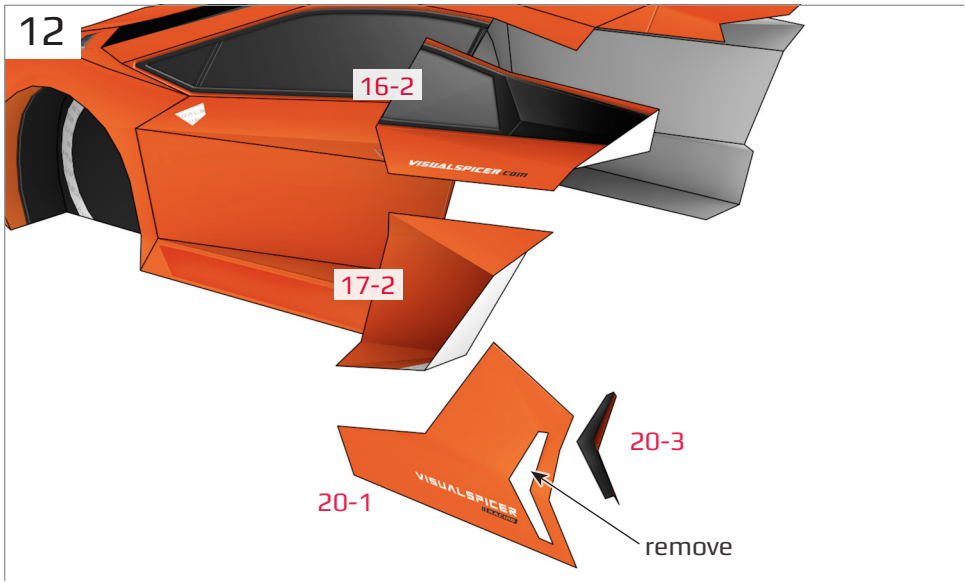

13

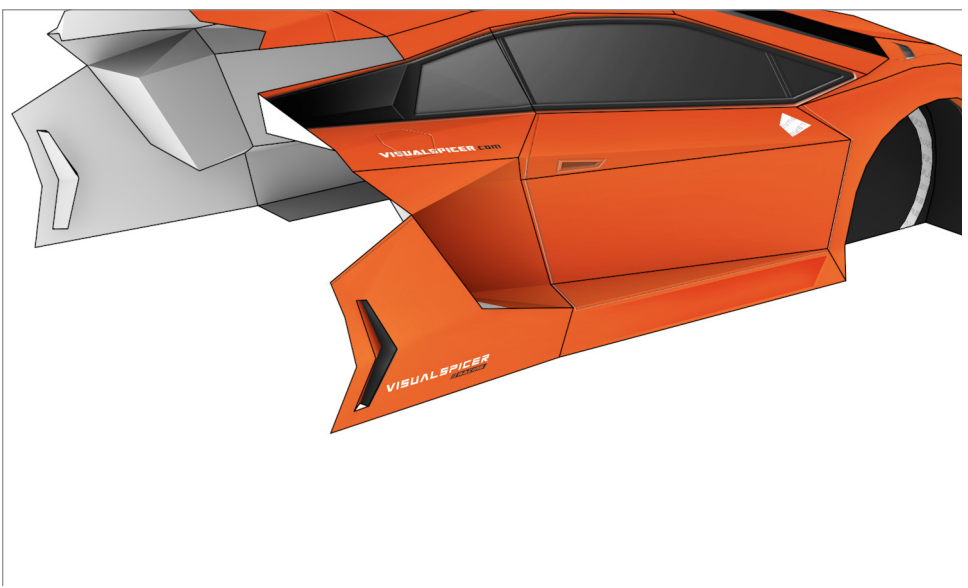
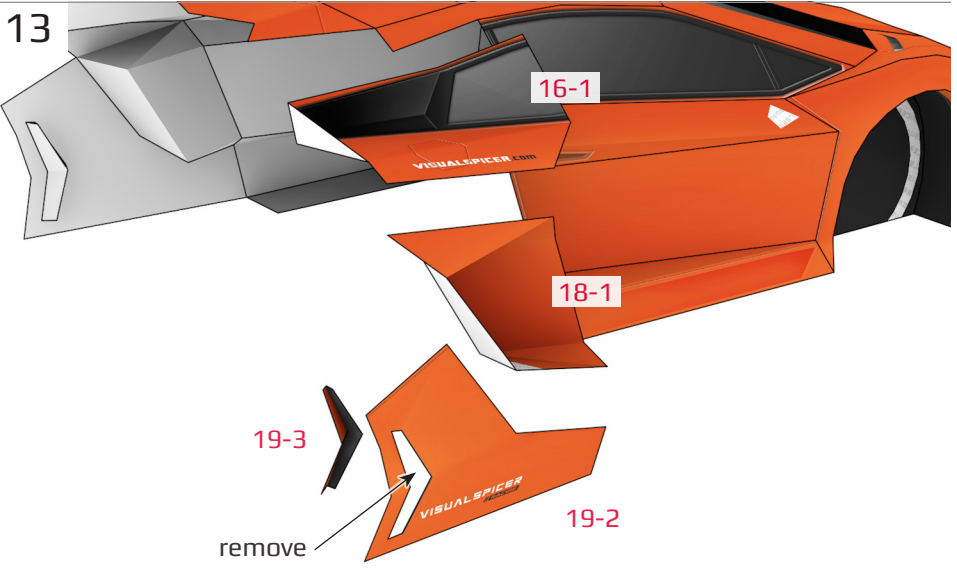

14

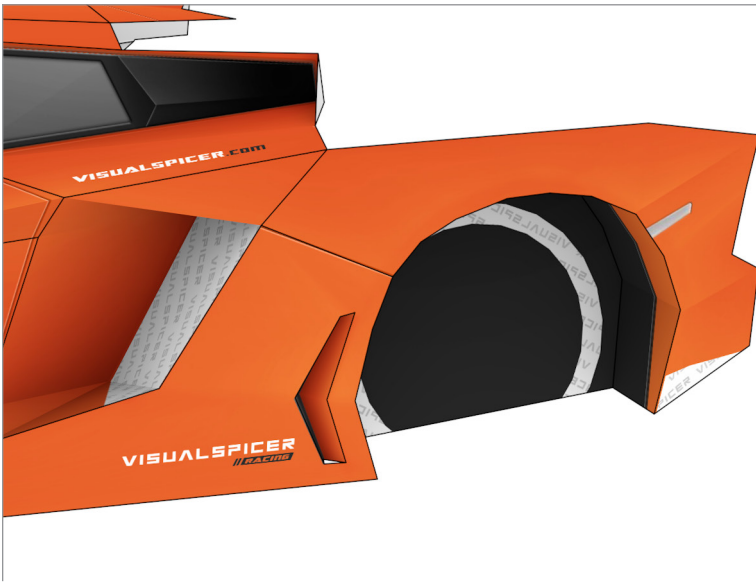
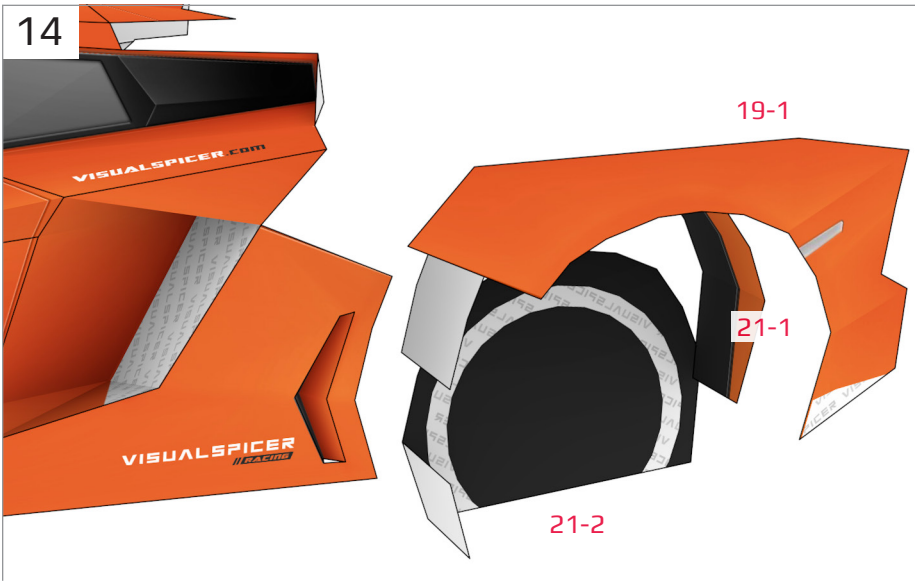

15

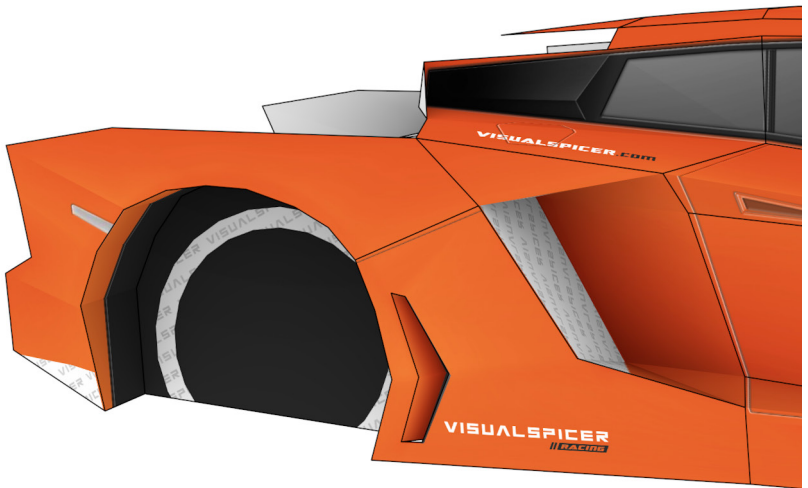
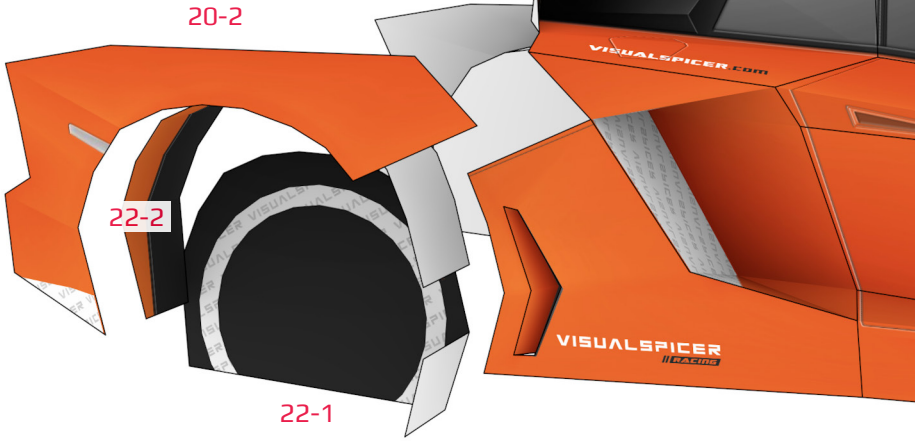

16

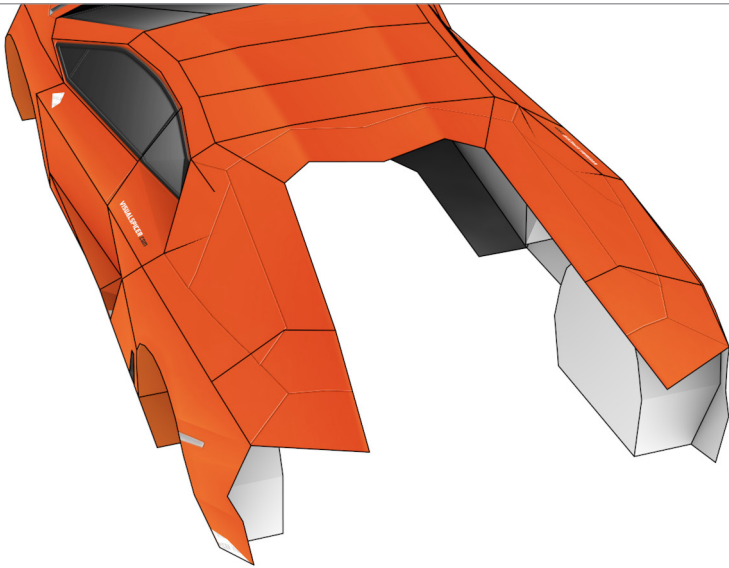
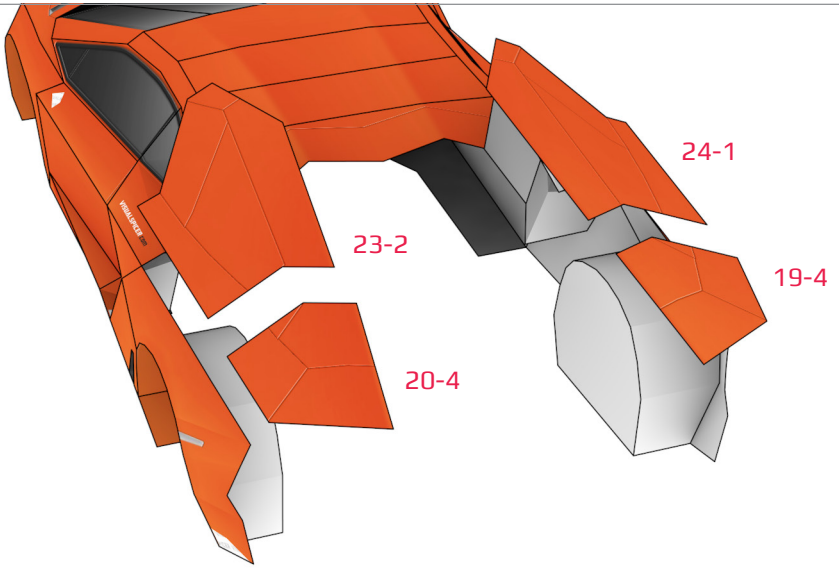

17

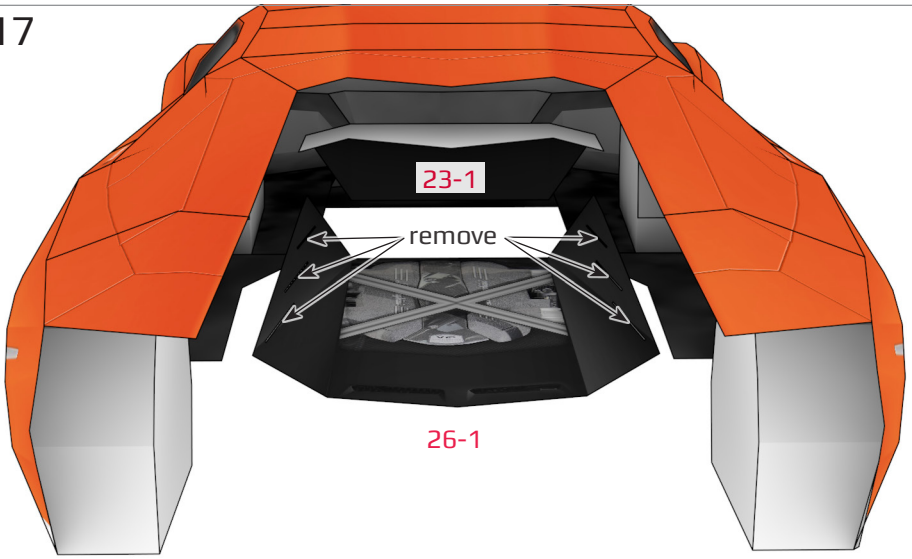

18

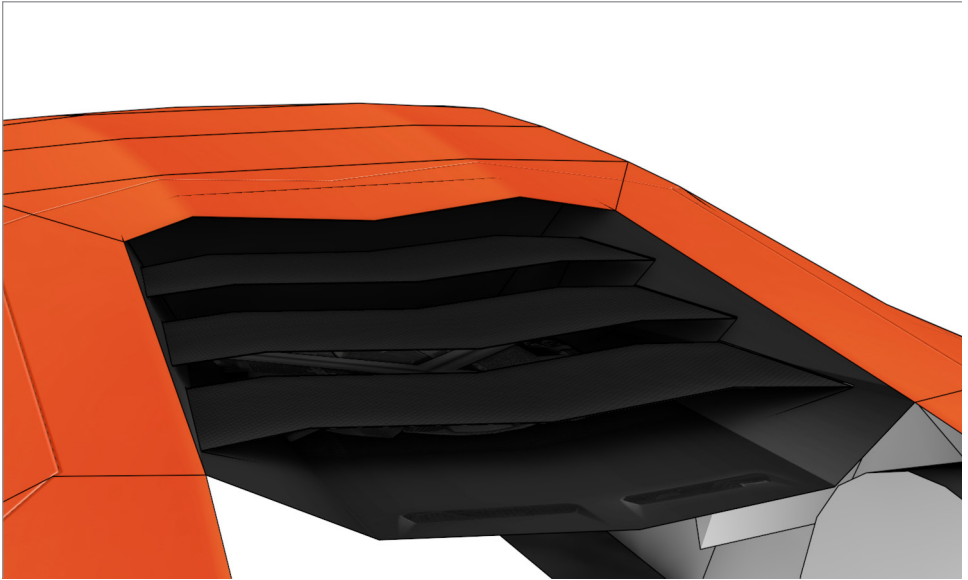
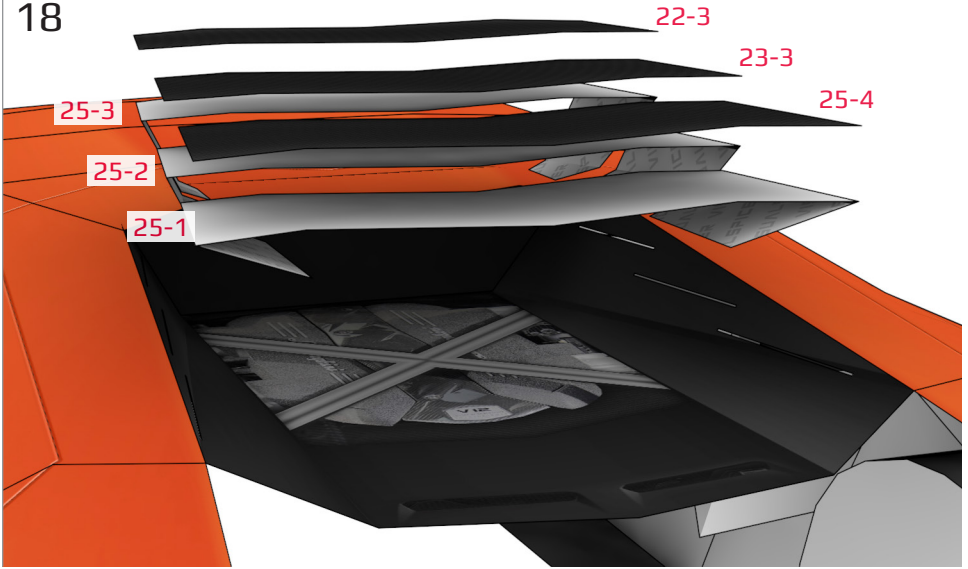

19

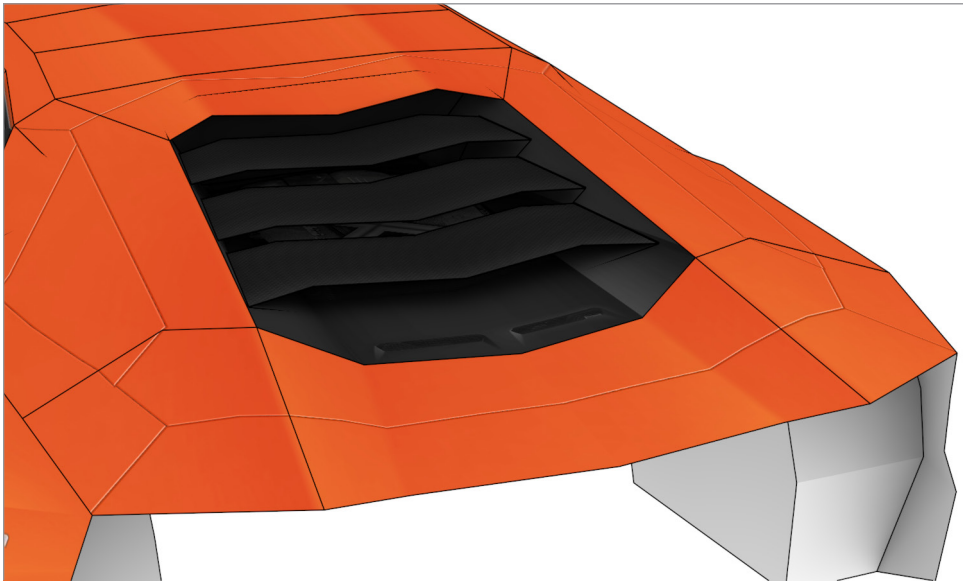
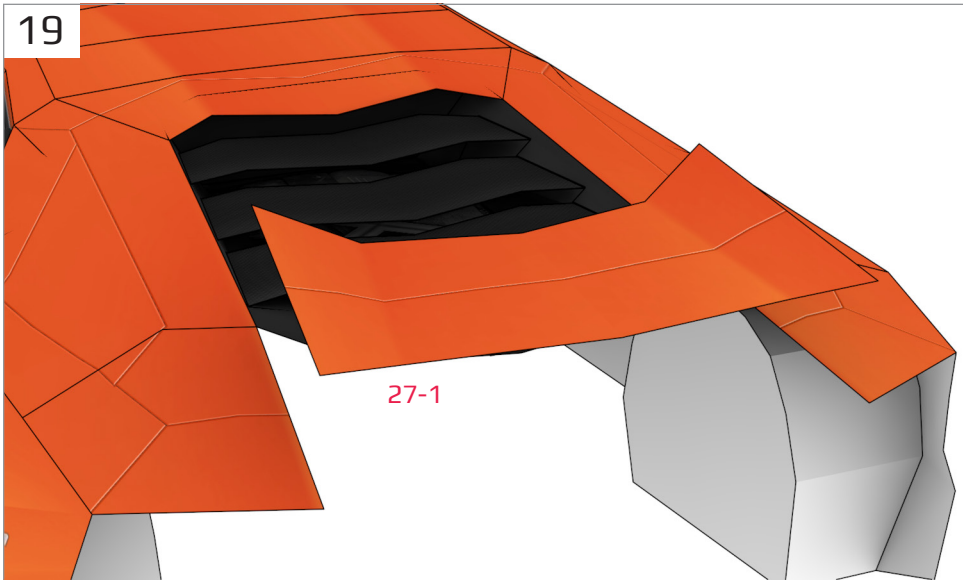

20

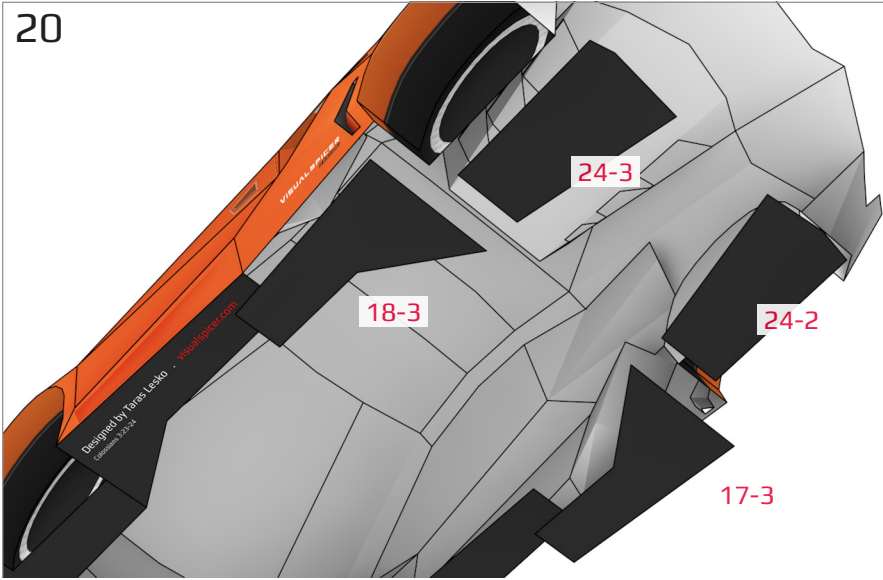

21

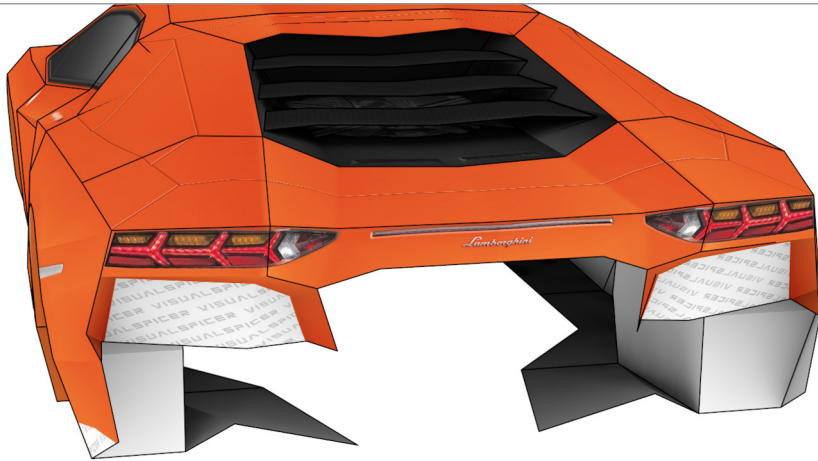
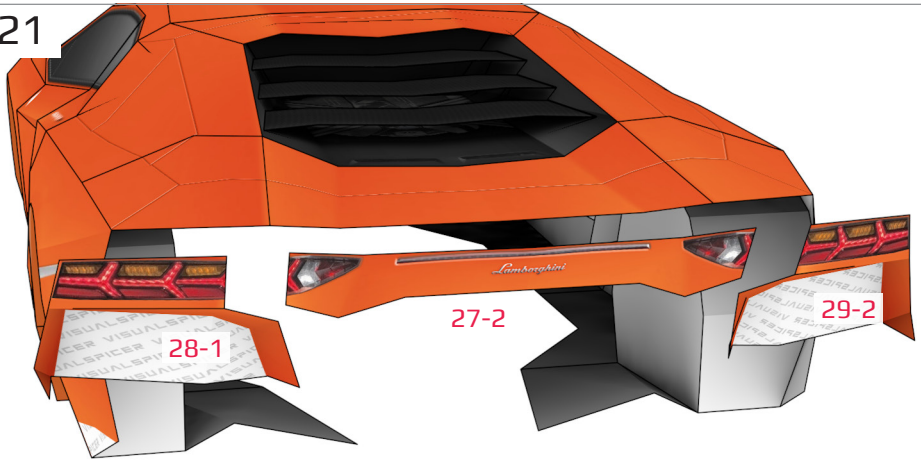

22

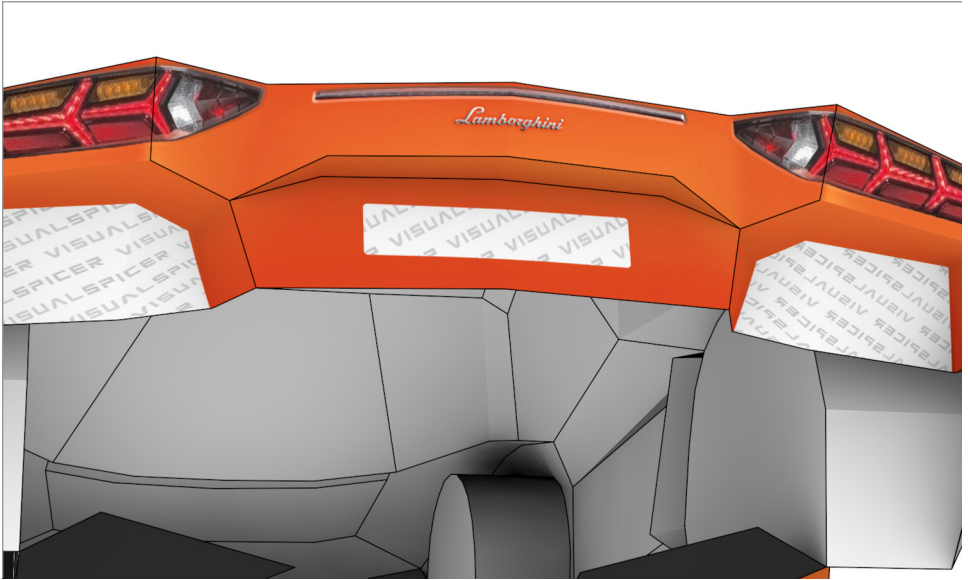
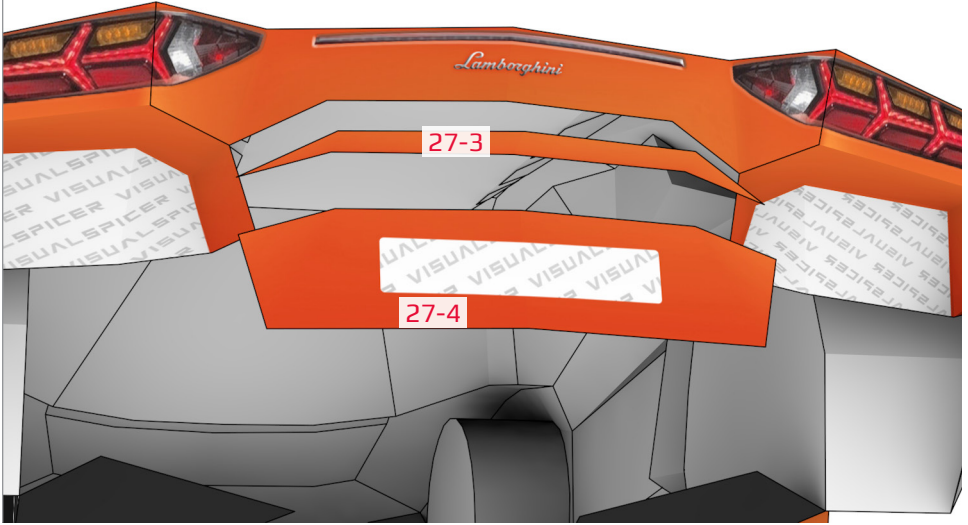

23

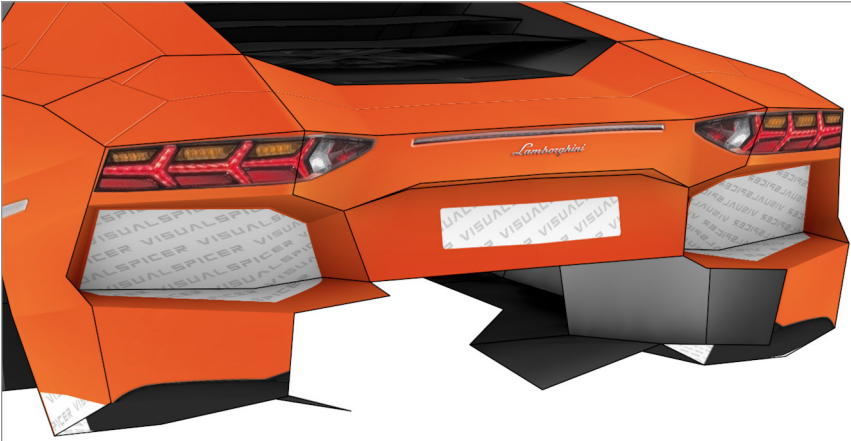
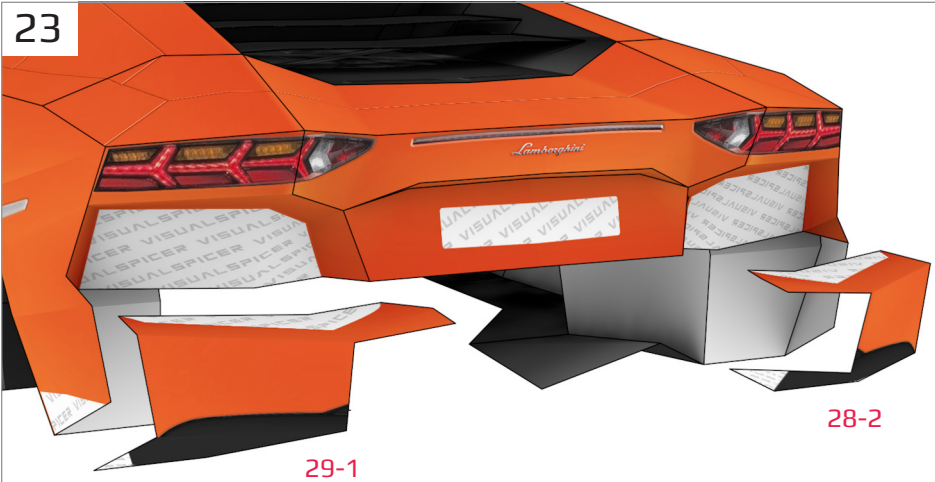

24

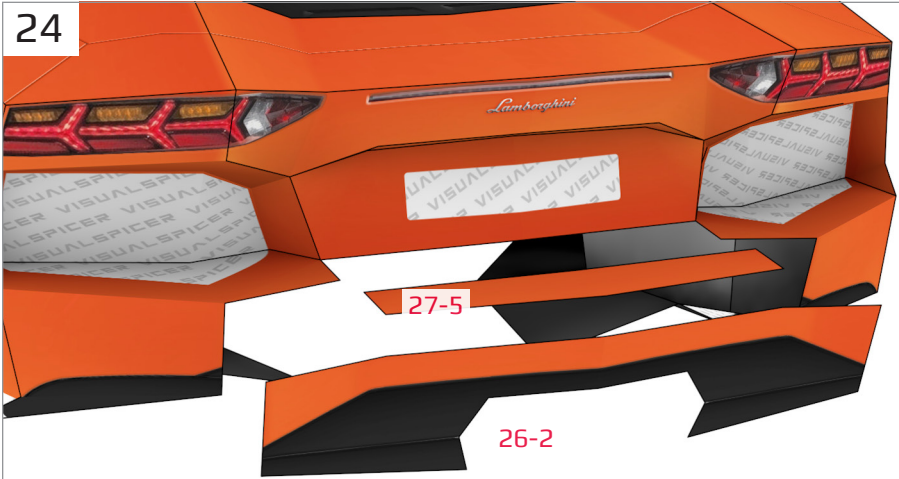

25

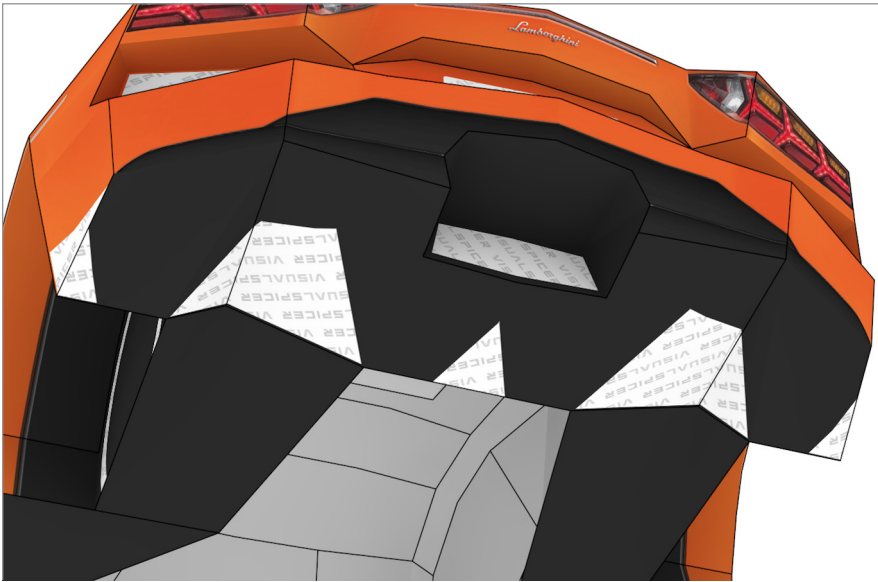
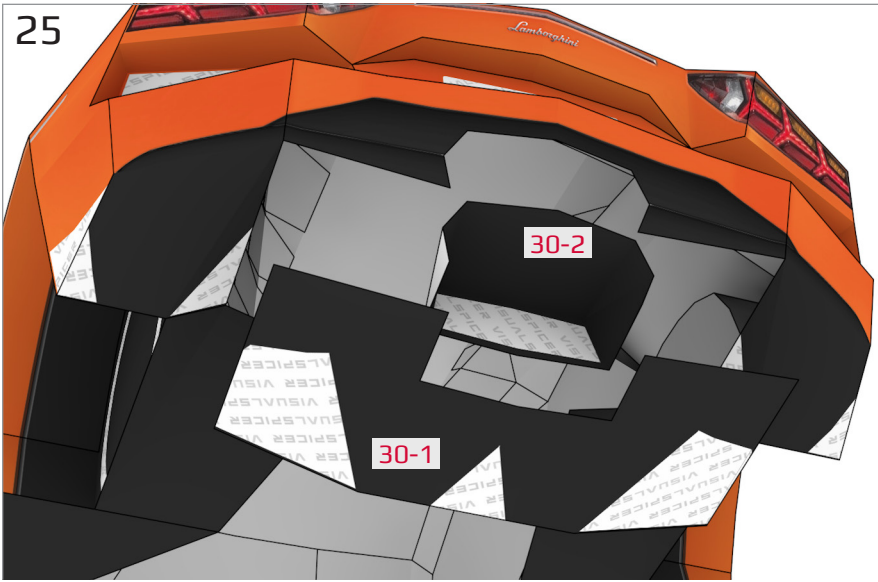

26

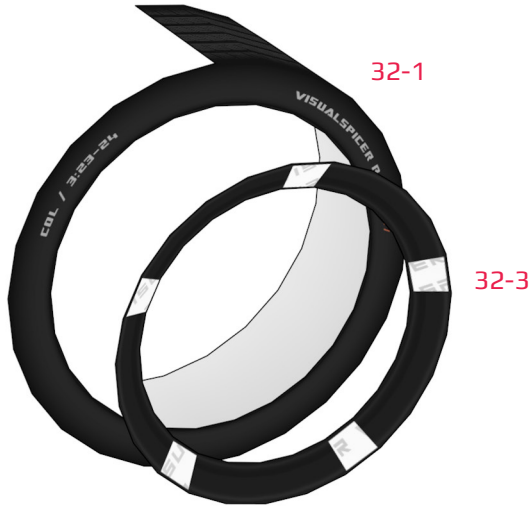

27

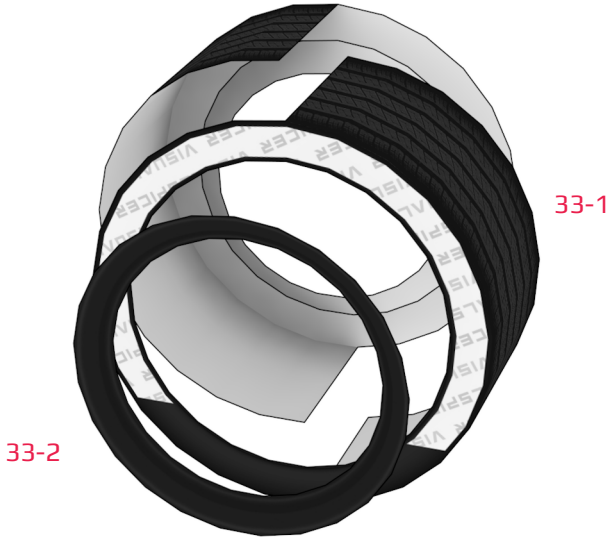

28



29

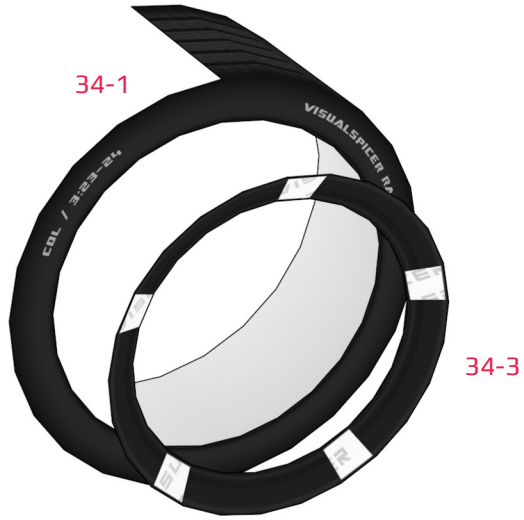

30

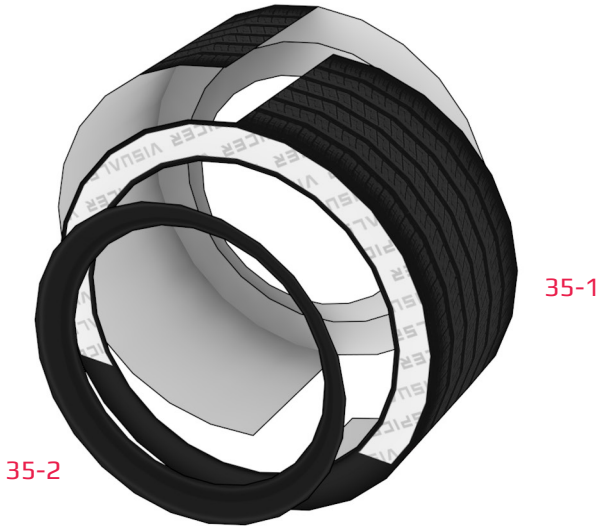

31



32

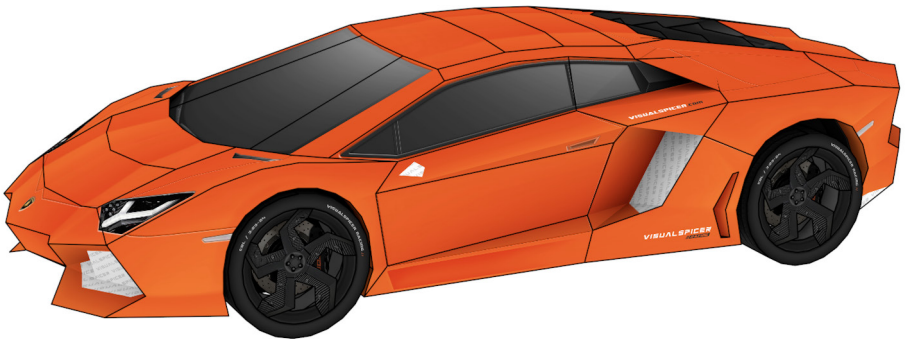

Mount wider wheel in rear.

33

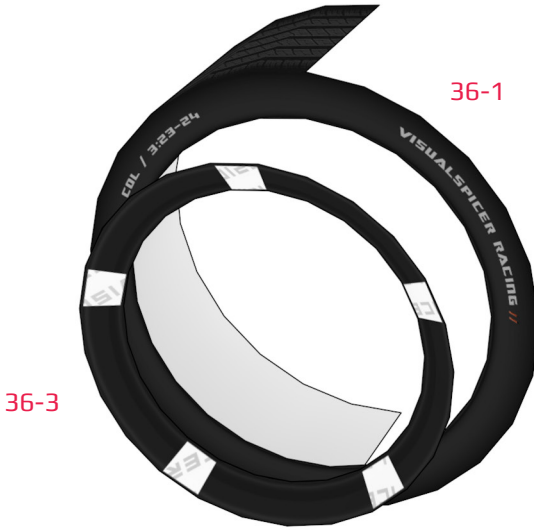

34

37-1

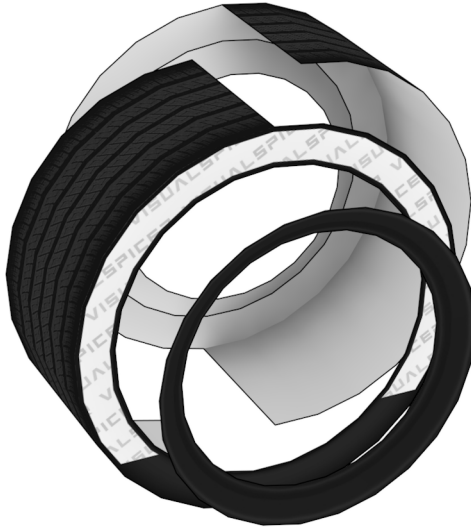

37-2



35



36

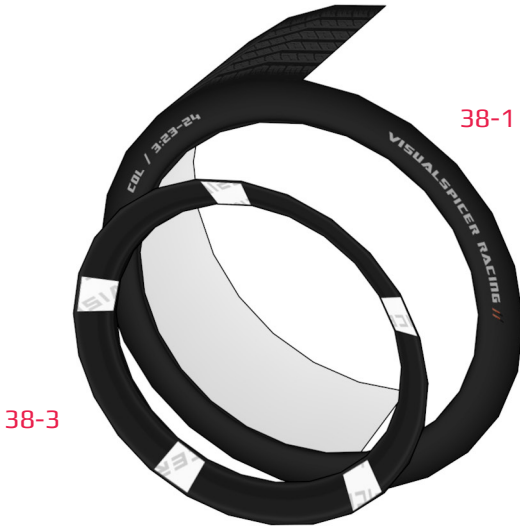

37

39-1

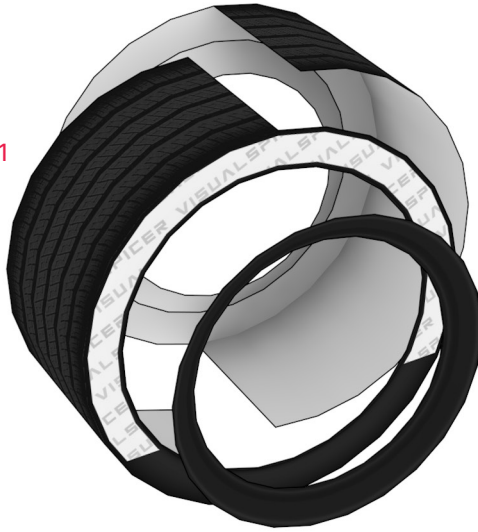

39-2



38



39

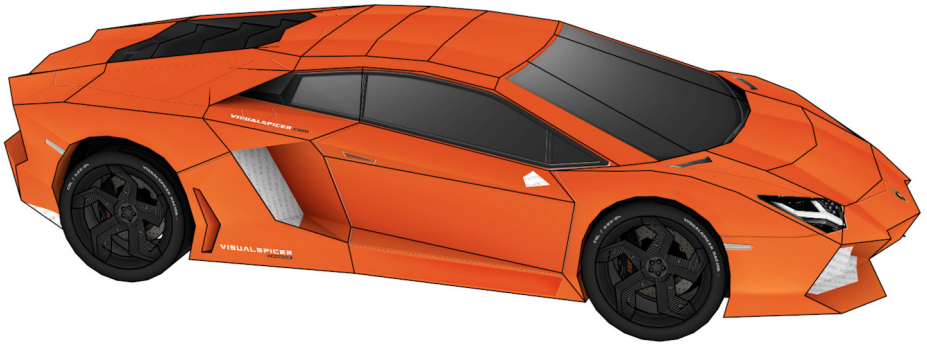

Mount wider wheel in rear.

40

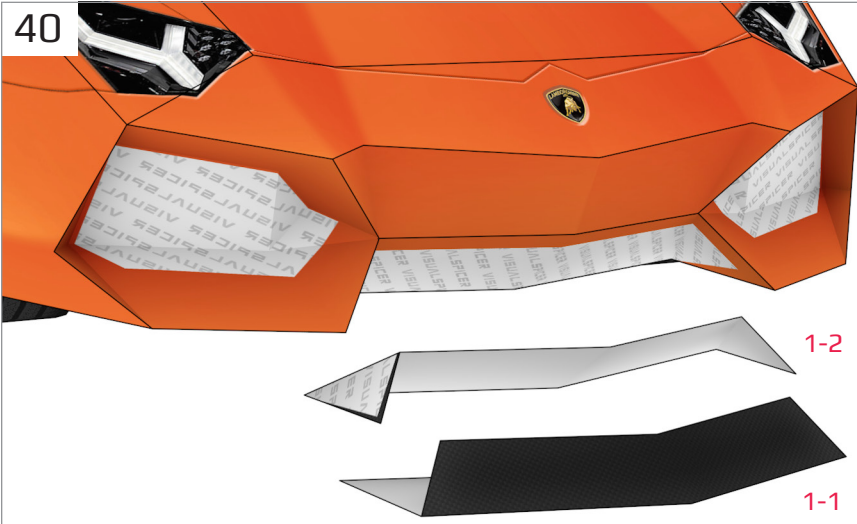

41

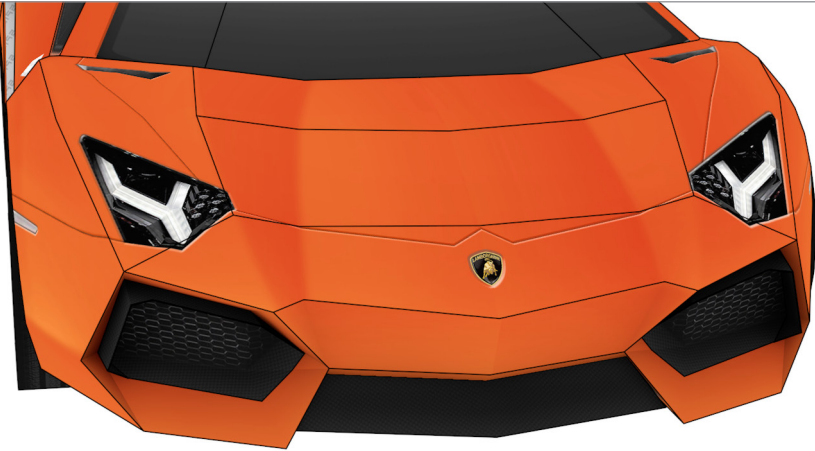
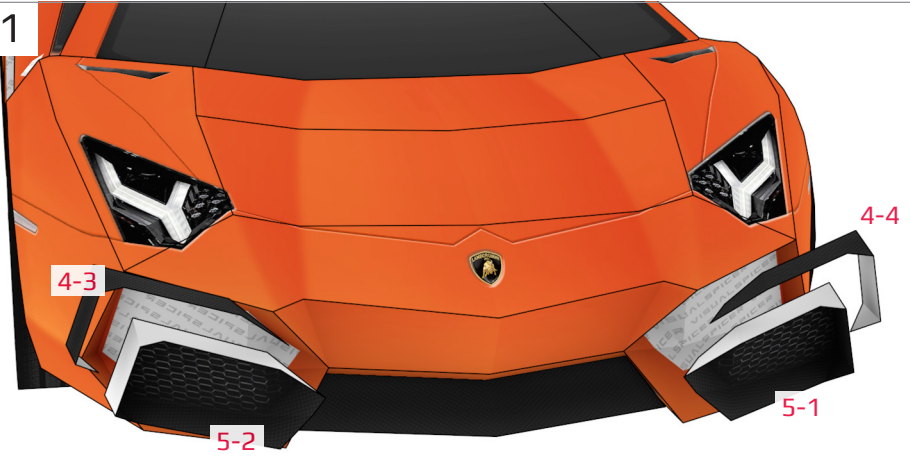

42

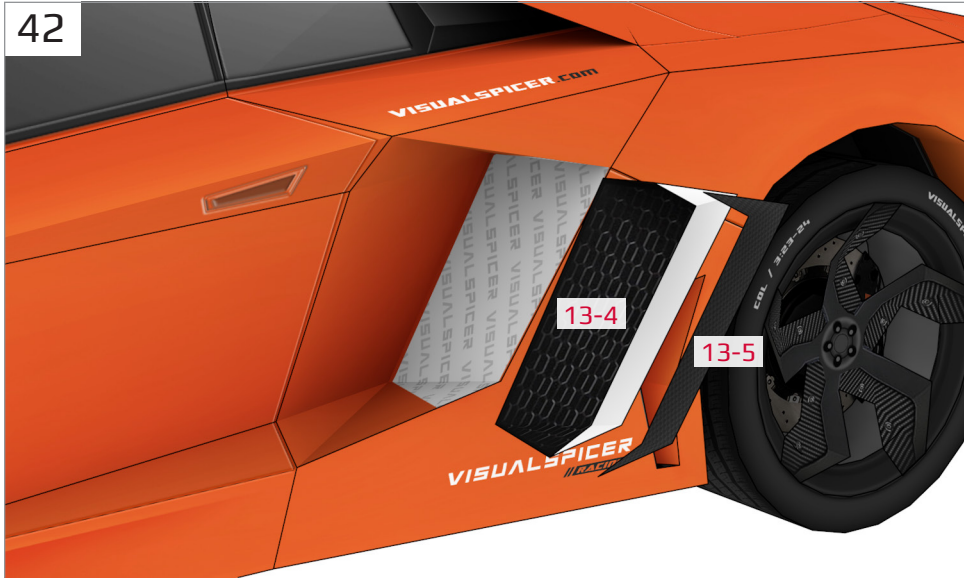

43



44



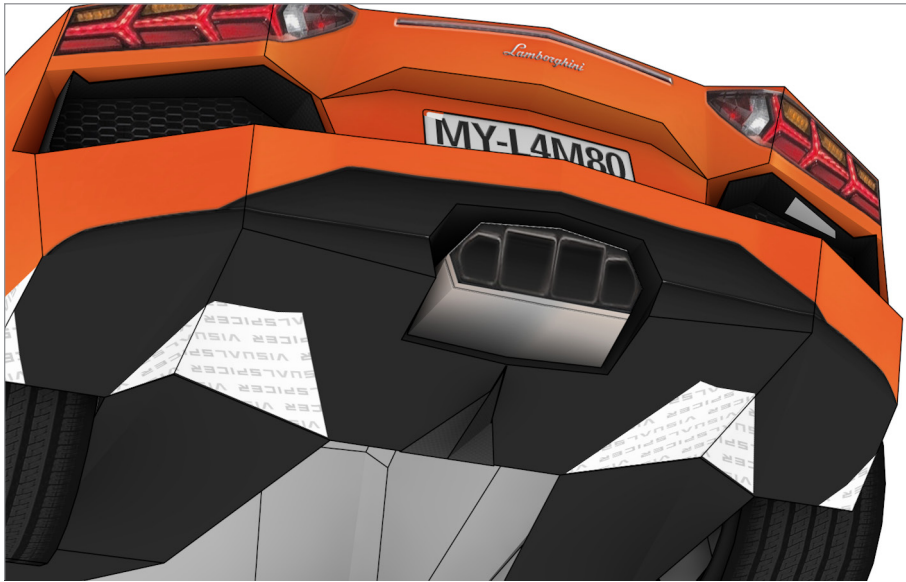
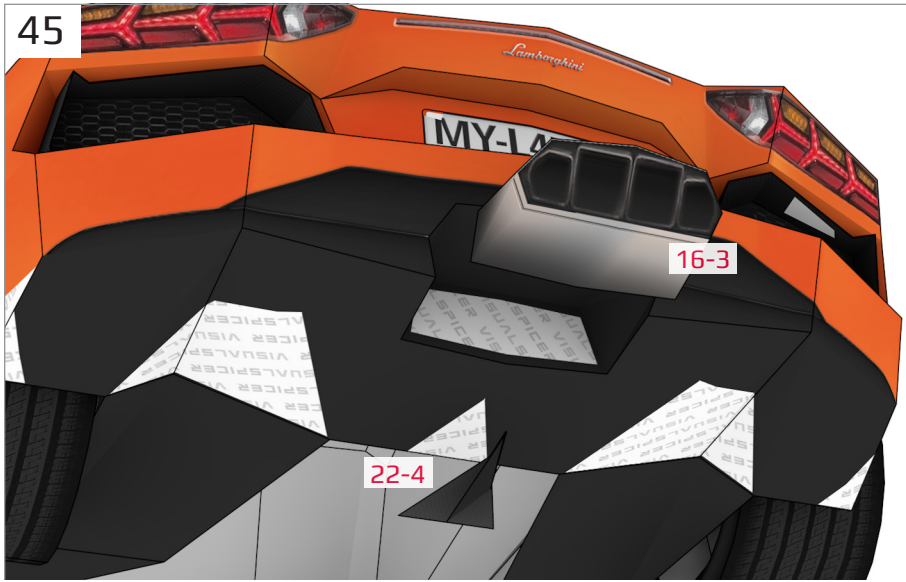

46



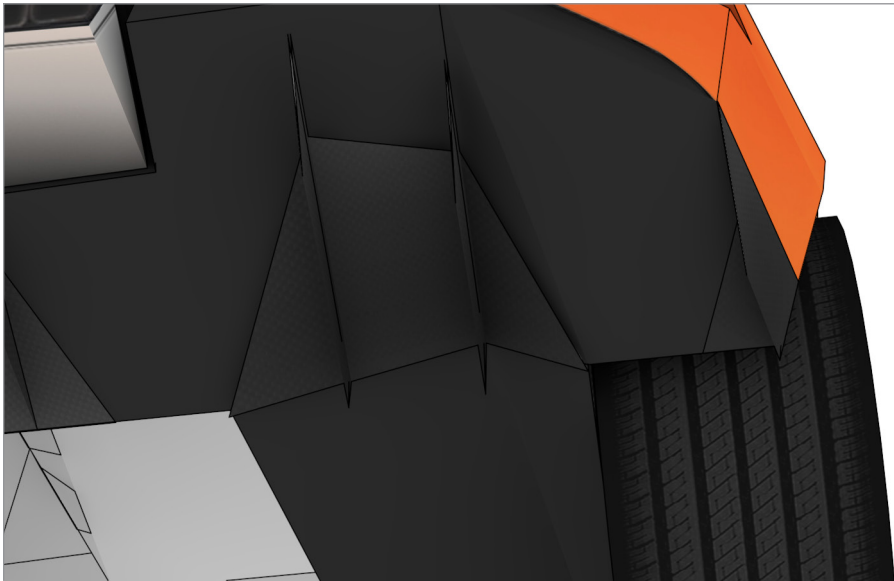
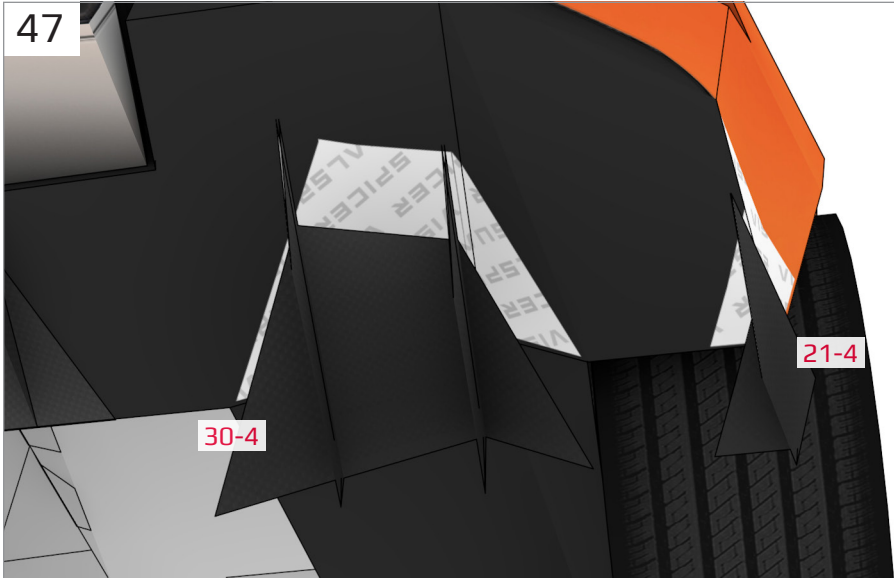

48

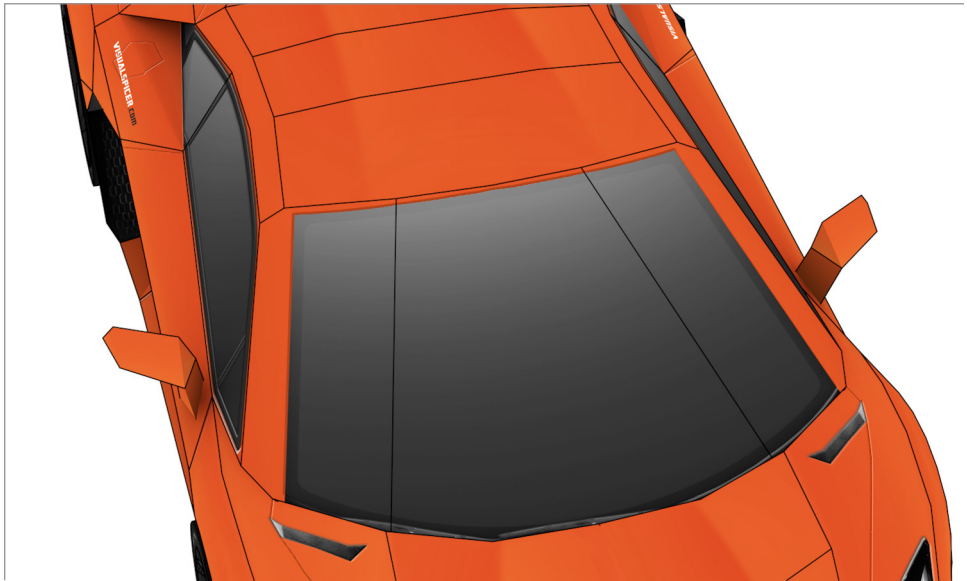
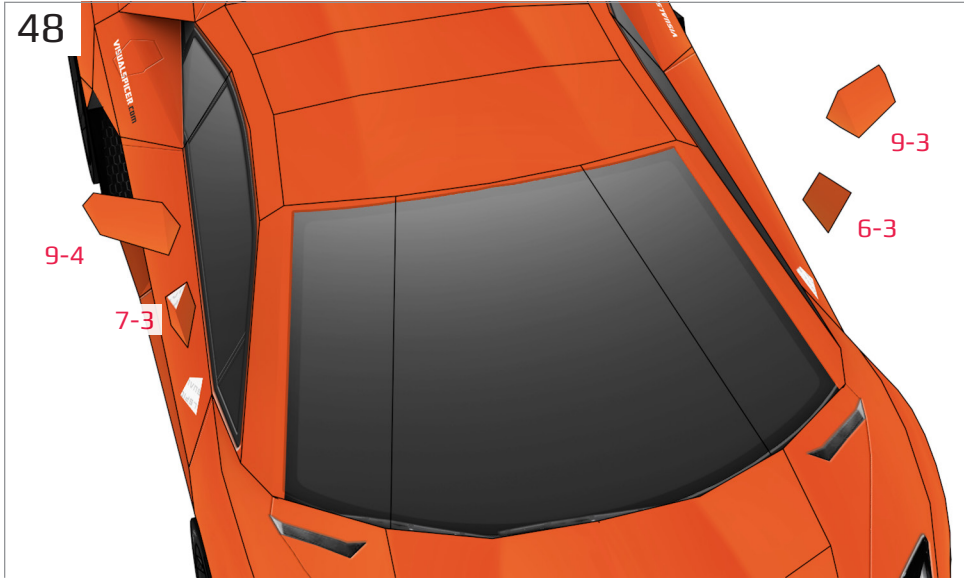

LAMBORGHINI AVENTADOR
PERFORMANCE WING

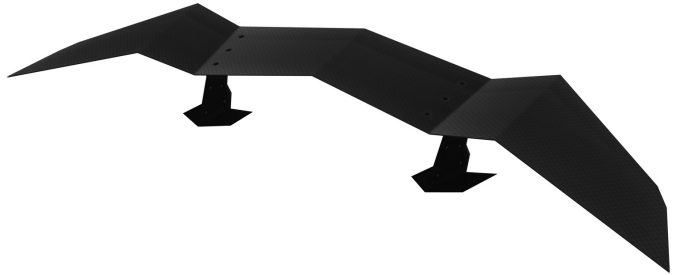

Designed by Taras Lesko
visualspicer.com

Recommended Tools

- Craft glue
- X-Acto knife
- Scissors
- Markers

Miscellaneous

- Glue only one part at a time.
- Glue only two or three tabs at a time.
- Experiment, enjoy and have fun!

Templates

- Cut line



- Mountain fold line 



- Valley fold line 



More Info

View more details about this project at bit.ly/AventadorPapercraft or scan the QR code to view the page on your mobile device.



1

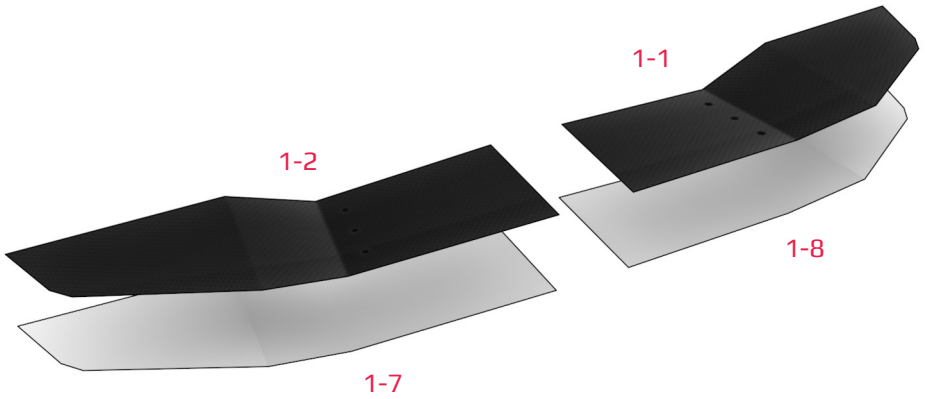

Find parts for each step by referencing Templates page number then part number. For example, **1-2** is Templates page 1, part 2.

2

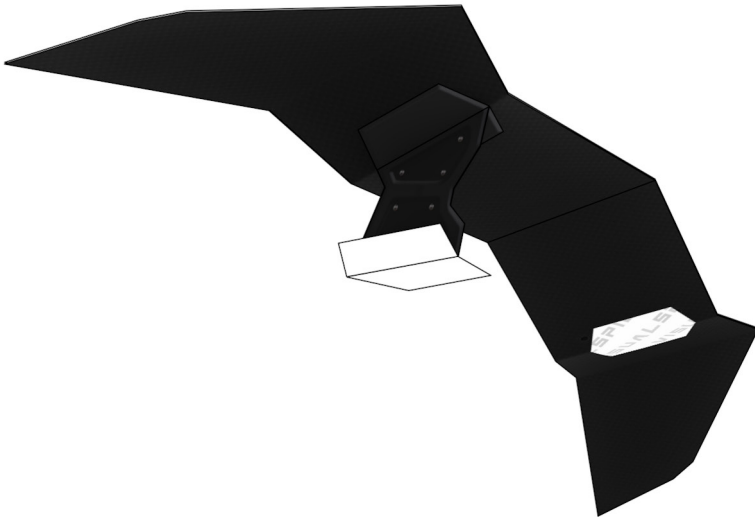
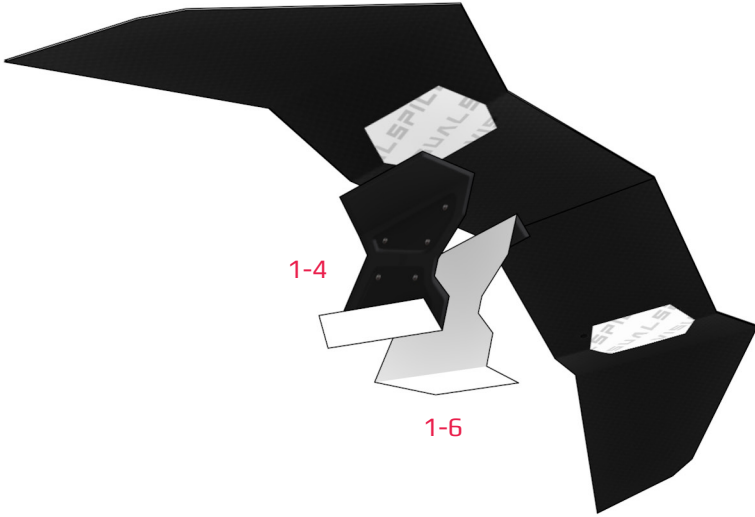

3

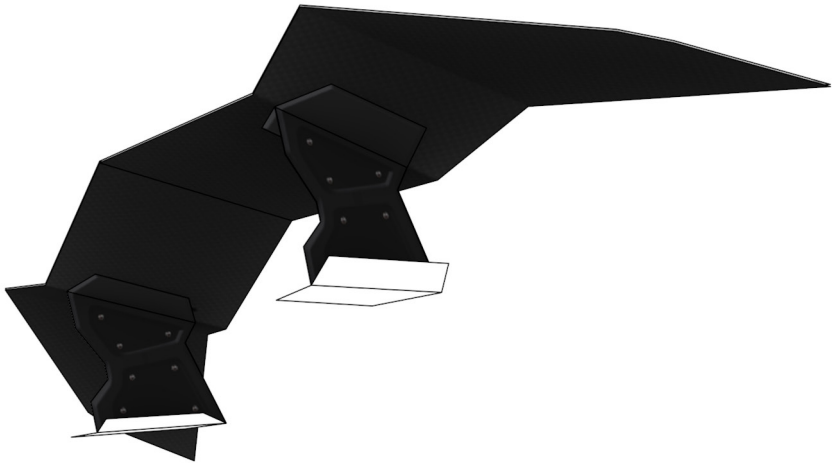
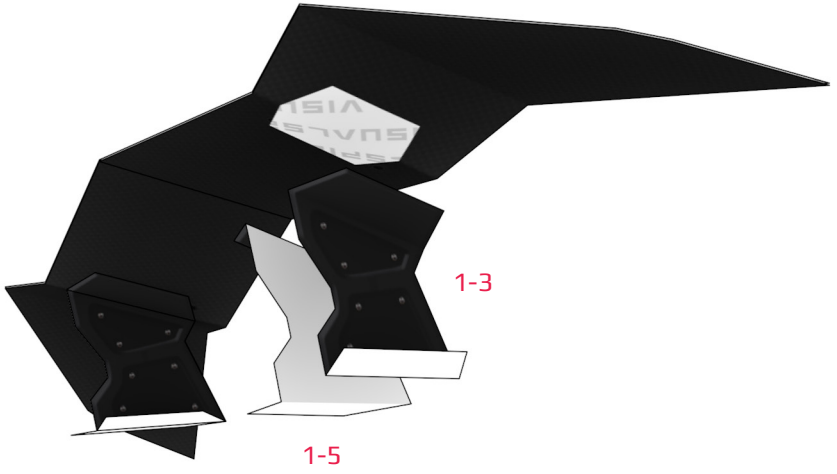

4



Placement on Lamborghini Aventador **Interceptor** model.

4

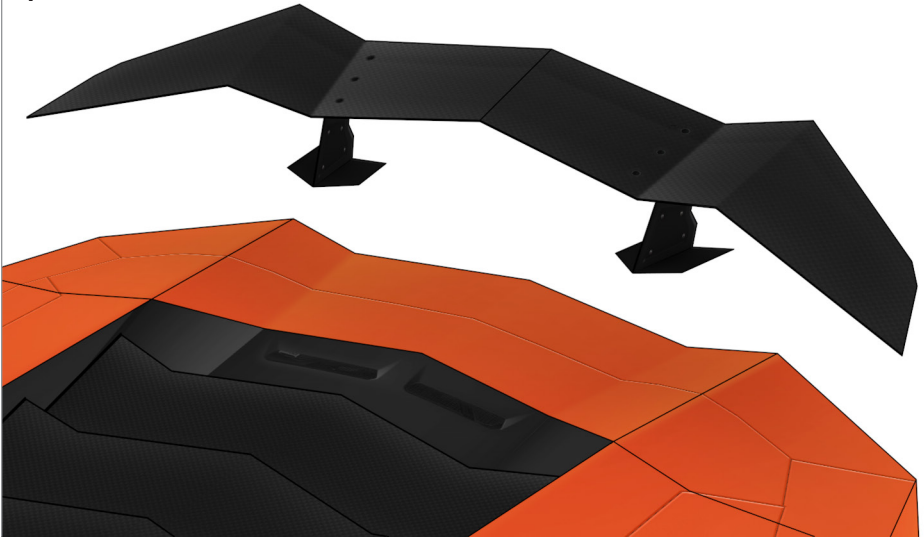

Placement on Lamborghini Aventador **Racer** model.

THANK YOU

Visit visualspicer.com for more of my creative work and downloadable papercrafts. Send questions, suggestions or comments to mail@visualspicer.com.



Colossians 3:23-24

Whatever my hands find to do, I work at it with all my heart,
as working for the Lord, Jesus Christ...

Model texturing by **Virgil Tuser** of Romania.

Proofing by **Andy Brine** of United Kingdom.

Test building by **Vladi Colton** of Israel.

Test building by **Martin Hazenberg** of Netherlands.

Test building by **Cody Thompson** of United States.